

TSM35-075-16-5V-060A-LW4



- Permanent Magnet Stepper Motor
- Precise Motion at a Low Cost
- 4.861 oz-in bipolar torque
- 35mm Diameter
- Customization Available for:
 - Winding Current Optimize Torque
 - Shaft Options
 - Cables and Connectors
- CE Certified and RoHS Compliant

Specifications

Item	Specifications
Step Angle Accuracy	± 8% (full step, no load)
Resistance Accuracy	± 10%
Inductance Accuracy	± 20%
Temperature Rise	80° C Max
Ambient Temperature	-20°C to +50°C
Insulation Resistance	100MOMin. 500VDC
Dielectric Strength	500VAC for one minute
Shaft Radial Play	0.06Max. (450 g-load)
Shaft Axial Play	0.08Max. (450 g-load)

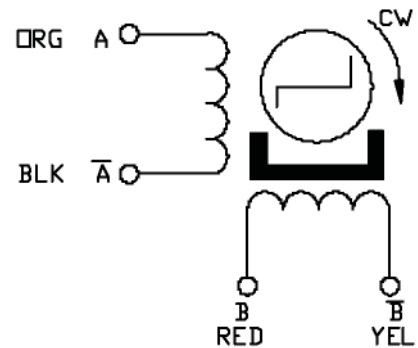

Model	Step Angle (deg)	# Of Wires	Voltage (V)	Current Per Phase (A)	Resistance Per Phase (ohms)	Holding Torque (g-cm)	Detent Torque (g-cm)	Rotor Inertia (g.cm ²)
TSM35-075-16-5V-060A-LW4	7.5	4	5	0.60	12	350	75	7.5

